

Video-Türsprechanlage TC:Bus für 1 Eingang mit Videoverteiler und Tag/Nacht Schaltgerät

Strang 1

Innensprechstellen/Rufeinheit

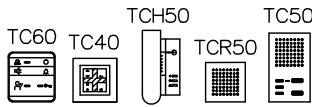

Video-Innensprechstellen

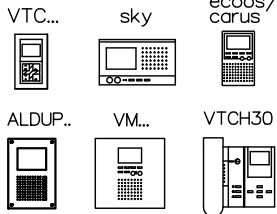

Video-Innensprechstellen

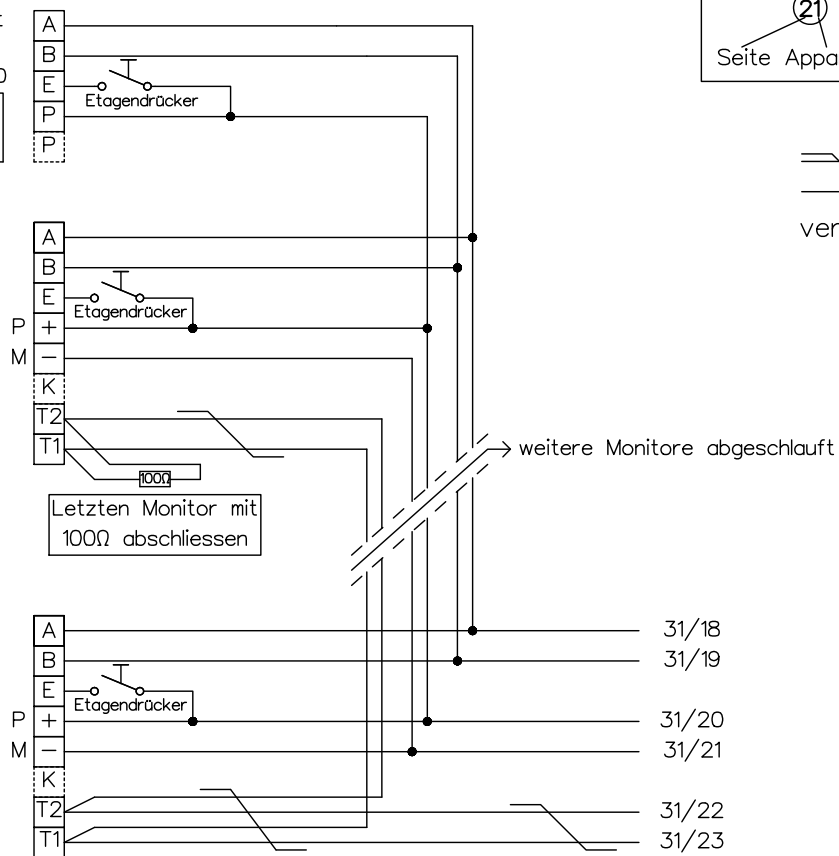
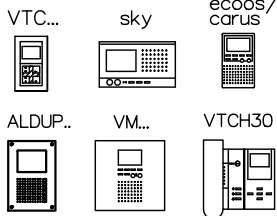

Strang 2

Video-Innensprechstellen

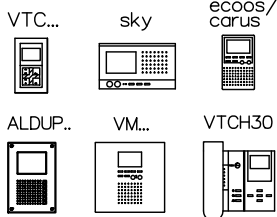

Video-Tischsprechstellen

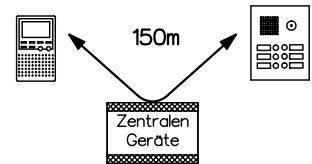
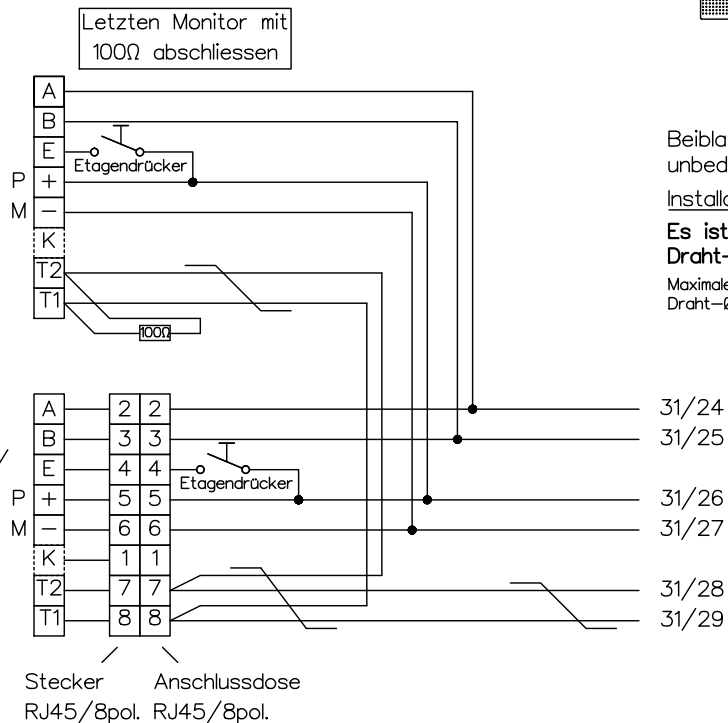
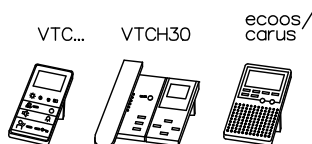

Beiblatt zu Schema TC:Bus unbedingt beachten!

Installationshinweise:

Es ist nur Kabel mit paarverdrillten Draht-Ø 0.8mm zulässig! (z.B. G51)

Maximale Leitungslänge pro Buslinie bei Draht-Ø 0.8mm bis 150m



René Koch AG
Seestrasse 241, 8804 Au/Wädenswil
044 782 6000, 044 782 6001 Fax
www.kochag.ch, info@kochag.ch

ISO 9001

Kunde		Komm.		Vg.	
Index	F	CAD	01295/166	Schema	TCV203/VV24/TN
Gez.	20.11.09 CN	Geänd.	01.12.15 CN	Geänd.	15.01.18 CN
				Blatt	1/3

Strang 3

Innensprechstellen/Rufeinheit

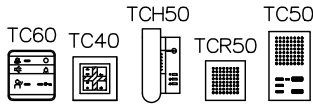

Video-Innensprechstellen

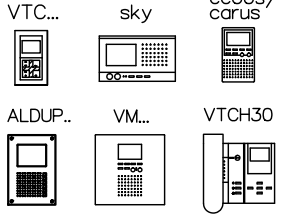

Video-Innensprechstellen

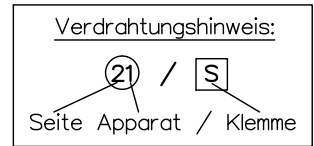
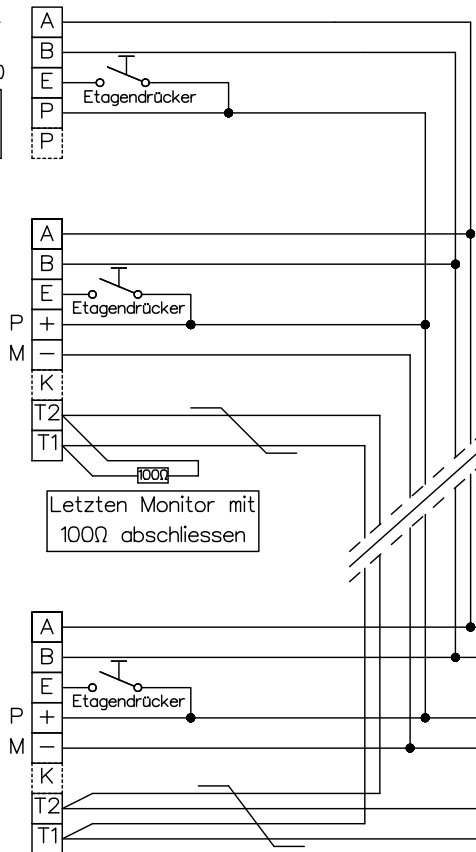
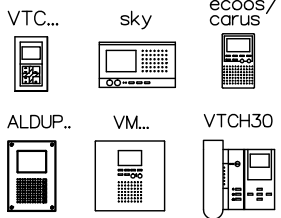

- 31/30
- 31/31
- 31/32
- 31/33
- 31/34
- 31/35

Strang 4

Video-Innensprechstellen

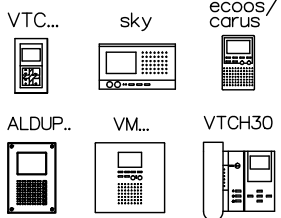

Video-Tischsprechstellen

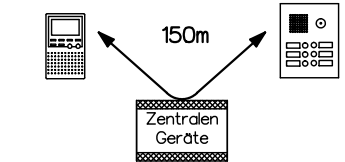
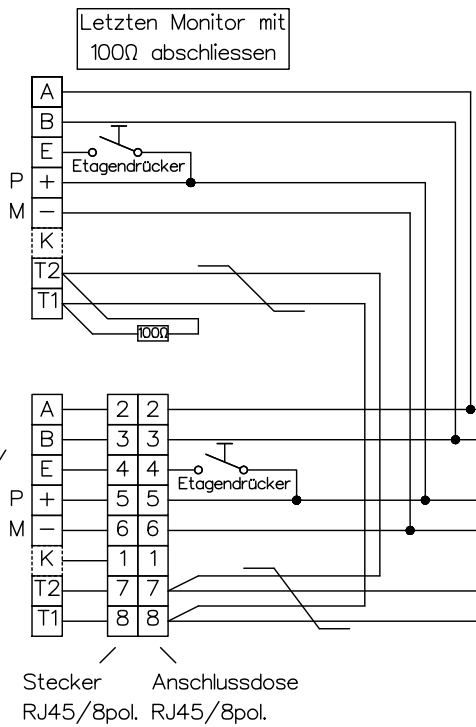
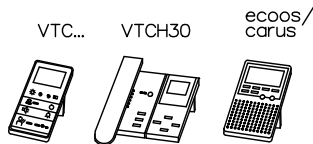

Beiblatt zu Schema TC:Bus unbedingt beachten!

Installationshinweise:

Es ist nur Kabel mit paarverdrillten Draht-Ø 0.8mm zulässig! (z.B. G51)

Maximale Leitungslänge pro Buslinie bei Draht-Ø 0.8mm bis 150m

- 31/12
- 31/13
- 31/14
- 31/15
- 31/16
- 31/17



René Koch AG
Seestrasse 241, 8804 Au/Wädenswil
044 782 6000, 044 782 6001 Fax
www.kochag.ch, info@kochag.ch

ISO 9001

Kunde

Kom.

Vg.

Index F

CAD 01295/168

Schema TCV203/VV24/TN

Gez. 20.11.09 CN

Geänd. 01.12.15 CN

Geänd. 15.01.18 CN

Blatt 2/3

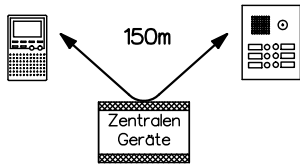
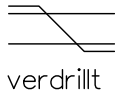

Beiblatt zu Schema TC:Bus
unbedingt beachten!

Installationshinweise:

Es ist nur Kabel mit paarverdrillten
Draht-Ø 0.8mm zulässig! (z.B. G51)

Maximale Leitungslänge pro Buslinie bei
Draht-Ø 0.8mm bis 150m

Einstellmöglichkeiten

BVS20/
BVS100/ Töffnerzeit 1Sek - 8Sek
VBVS05: Lichtschaltzeit 1Sek - 5Min

Die neuen Einstellungen
sind erst aktiv, nachdem
man die Programmier-
taste 2 Mal betätigt hat.

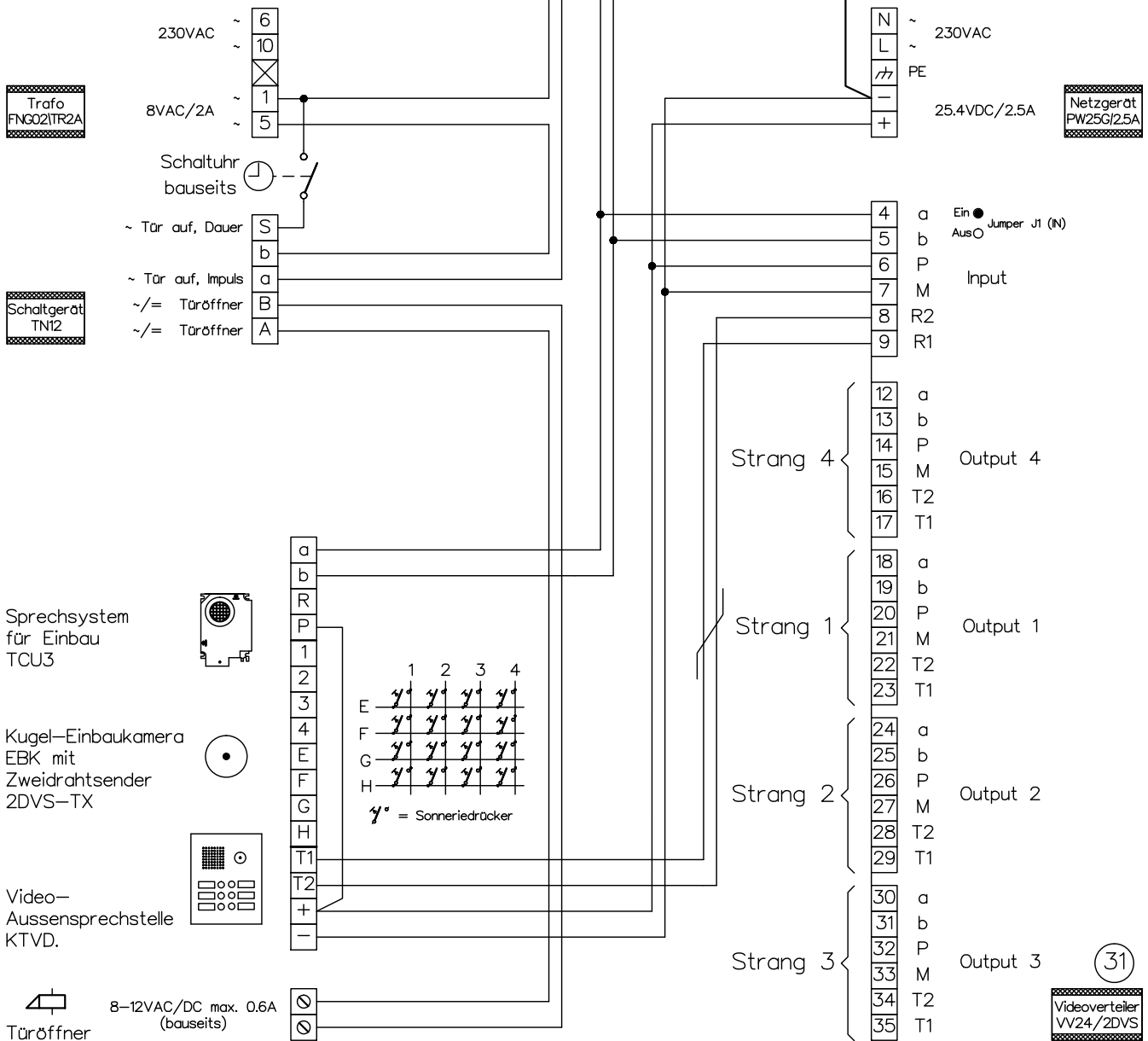

René Koch AG
Seestrasse 241, 8804 Au/Wädenswil
044 782 6000, 044 782 6001 Fax
www.kochag.ch, info@kochag.ch

ISO 9001

Kunde			
Kom.		Vg.	
Index F	CAD 01295/170	Schema TCV203/VV24/TN	
Gez. 20.11.09 CN	Geänd. 01.12.15 CN	Geänd. 15.01.18 CN	Blatt 3/3