

Video-Türsprechanlage TC:Bus für 1 Eingang mit Videoverteiler

Strang 1

Innensprechstellen/Rufeinheit

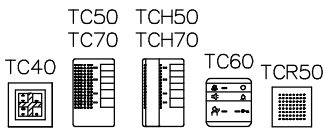

Video-Innensprechstellen

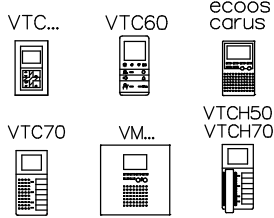

Video-Innensprechstellen

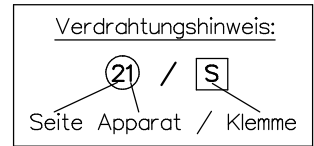
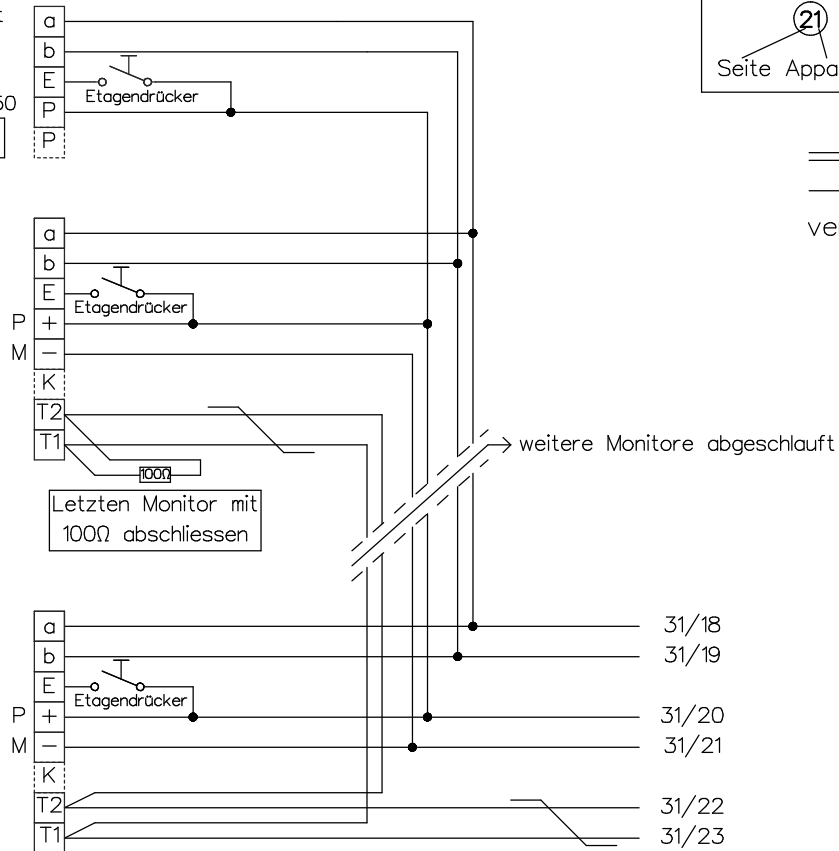
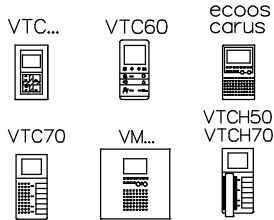

Strang 2

Video-Innensprechstellen

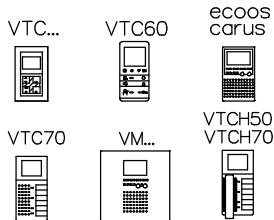

Video-Tischsprechstellen

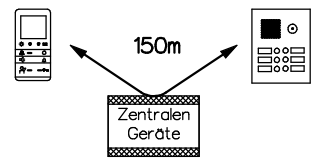
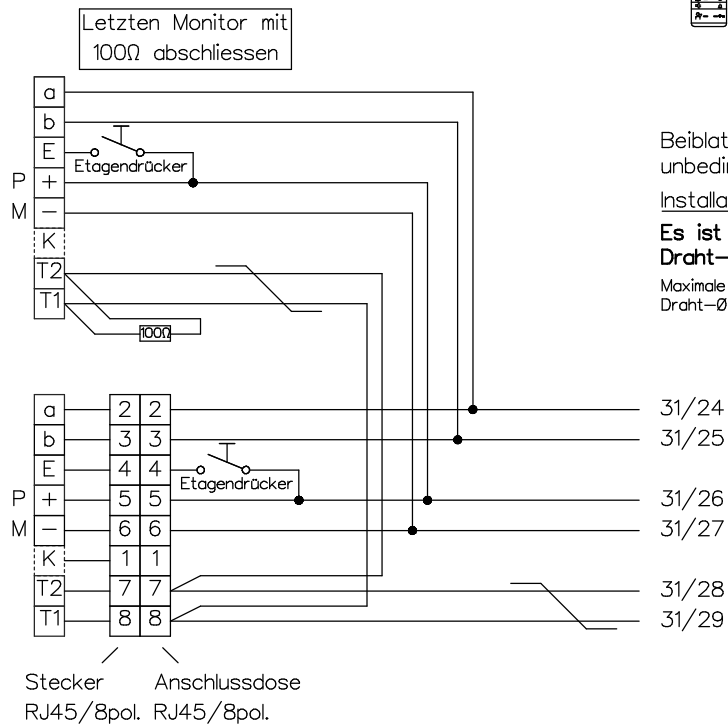
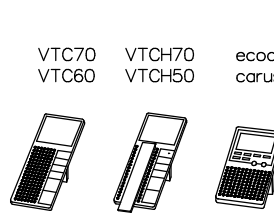

Beiblatt zu Schema TC:Bus unbedingt beachten!

Installationshinweise:

Es ist nur Kabel mit paarverdrillten Draht-Ø 0.8mm zulässig! (z.B. G51)

Maximale Leitungslänge pro Buslinie bei Draht-Ø 0.8mm bis 150m



René Koch AG
Seestrasse 241, 8804 Au/Wädenswil
044 782 6000
www.kochag.ch, info@kochag.ch

ISO 9001

Kunde		Vg.	
Kom.			
Index F	CAD 01331/134	Schema TCV254/VV24/EBK/2DVS	
Gez. 21.12.21 CN	Geänd. 12.01.24 CN	Geänd.	Blatt 1/3

Video-Türsprechanlage TC:Bus für 1 Eingang mit Videoverteiler

Strang 3

Innensprechstellen/Rufeinheit

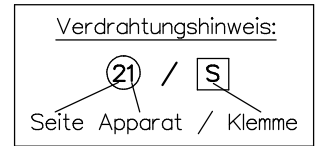
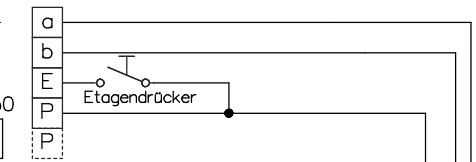
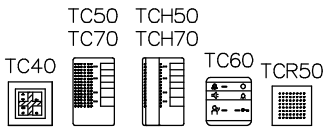

Video-Innensprechstellen

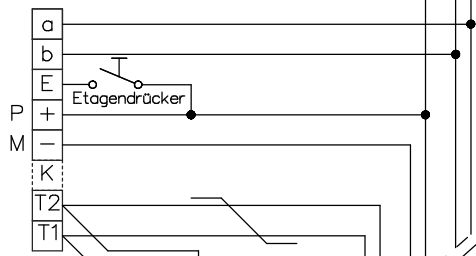
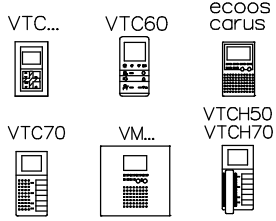

Letzten Monitor mit 100Ω abschliessen

weitere Monitore abgeschlufft

Video-Innensprechstellen

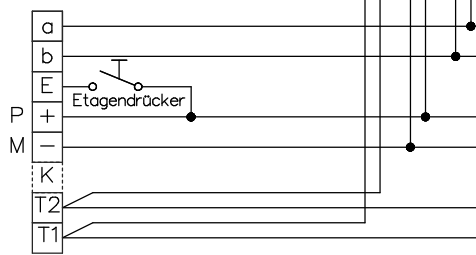
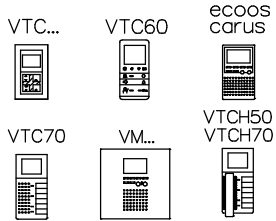

Strang 4

Letzten Monitor mit 100Ω abschliessen

Video-Innensprechstellen

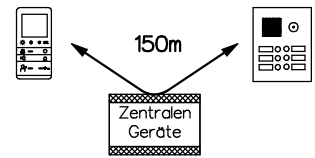
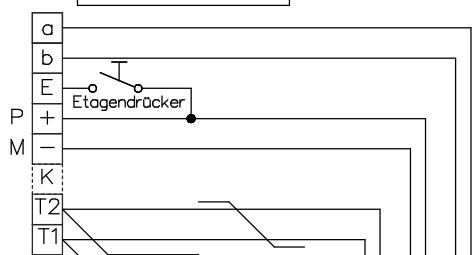
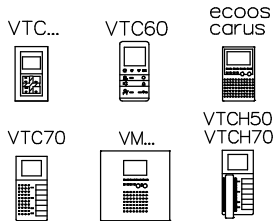

Beiblatt zu Schema TC:Bus unbedingt beachten!

Installationshinweise:

Es ist nur Kabel mit paarverdrillten Draht-Ø 0.8mm zulässig! (z.B. G51)

Maximale Leitungslänge pro Buslinie bei Draht-Ø 0.8mm bis 150m

Video-Tischsprechstellen

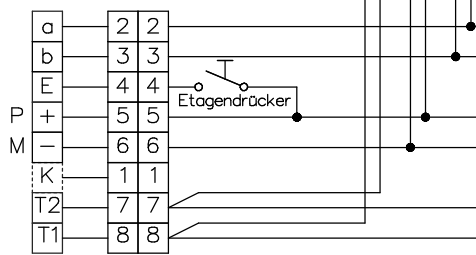
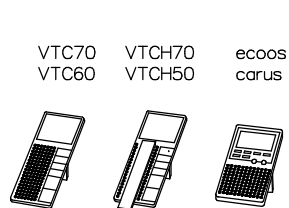

Stecker RJ45/8pol. Anschlussdose RJ45/8pol.



René Koch AG
Seestrasse 241, 8804 Au/Wädenswil
044 782 6000
www.kochag.ch, info@kochag.ch

ISO 9001

Kunde		Vg.	
Kom.		Vg.	
Index F	CAD 01331/136	Schema TCV254/VV24/EBK/2DVS	
Gez. 21.12.21 CN	Geänd. 12.01.24 CN	Geänd.	Blatt 2/3

Video-Türsprechanlage TC:Bus für 1 Eingang mit Videoverteiler

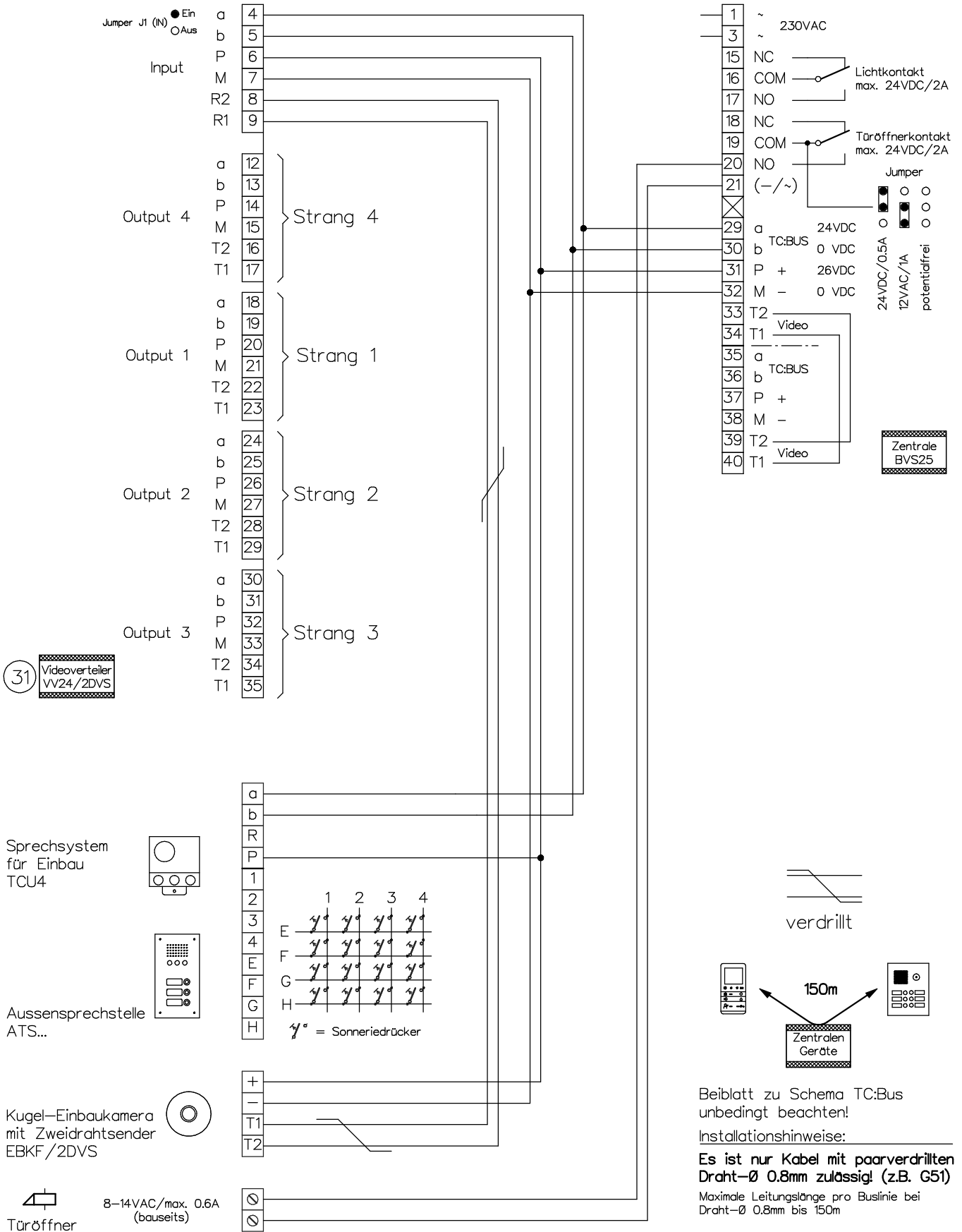

René Koch AG
 Seestrasse 241, 8804 Au/Wädenswil
 044 782 6000
 www.kochag.ch, info@kochag.ch

ISO 9001

Kunde			
Kom.		Vg.	
Index F	CAD 01331/138	Schema TCV254/VV24/EBK/2DVS	
Gez. 21.12.21 CN	Geänd. 12.01.24 CN	Geänd.	Blatt 3/3